



Communicate with **Confidence.**

150 Flagship Drive, North Andover, MA 01845

Telephone: 978.975.3100 800.733.1520

2009 Die Catalog

Contained here within this report is a visual representation of Flagship Press' die catalog. If any of the product shown is of interest, please coordinate with the procurement department as to how to layout the job.

Shown in this catalog:

- Business Card Slit Suggestions (Dies onhand)
 - 2000 Series Folders (Dies onhand)
 - Die Catalog Listing by size

Samples will be available upon request.

This is an ongoing and ever updating catalog.

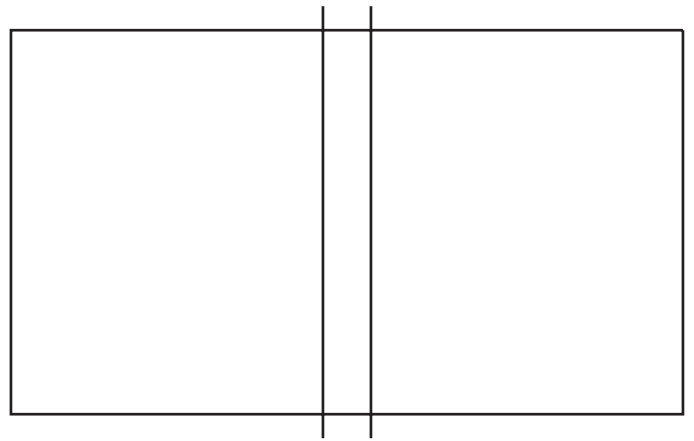
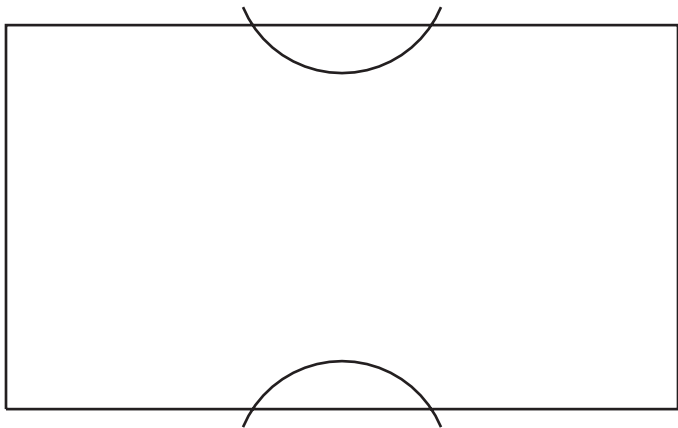
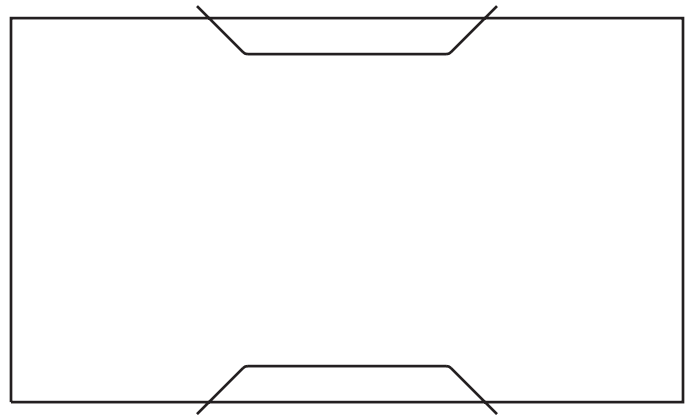
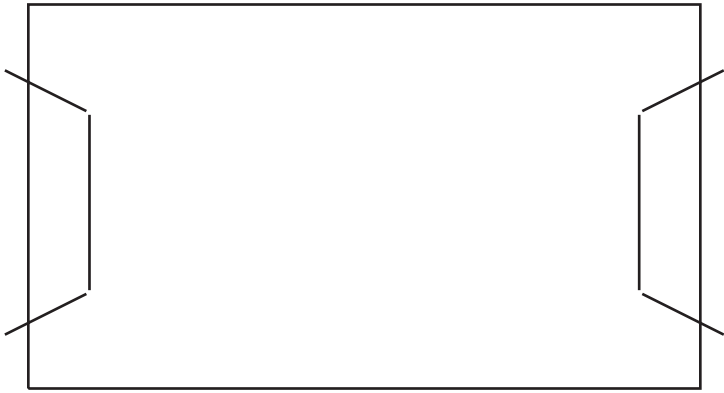
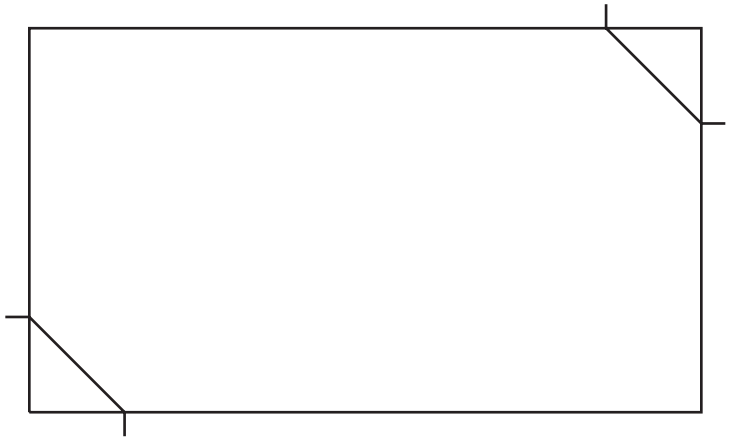
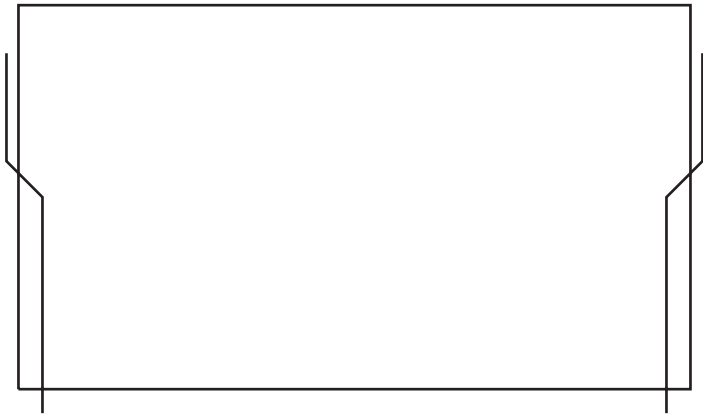
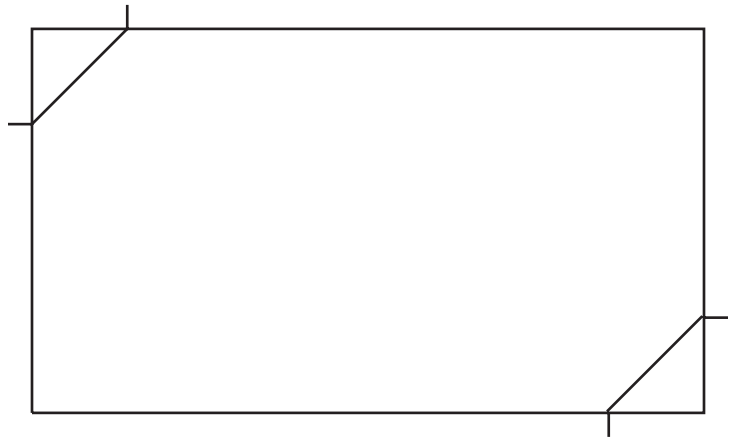
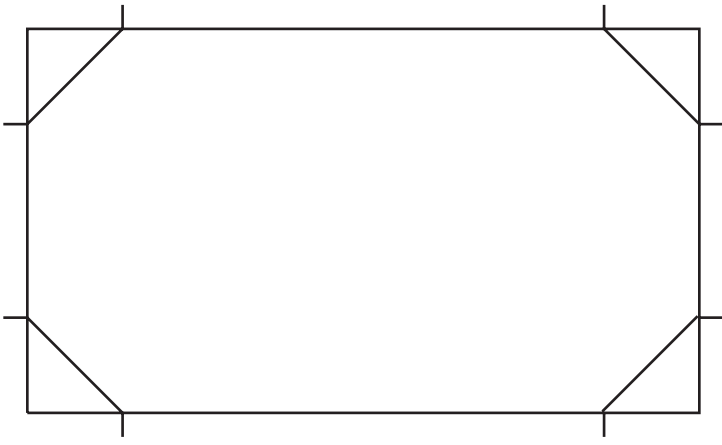

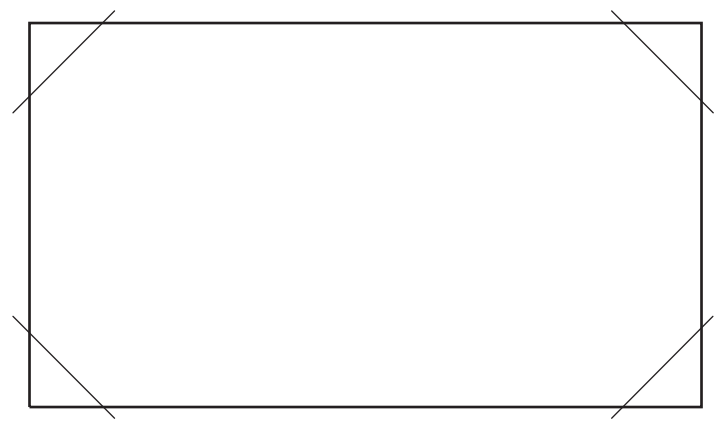
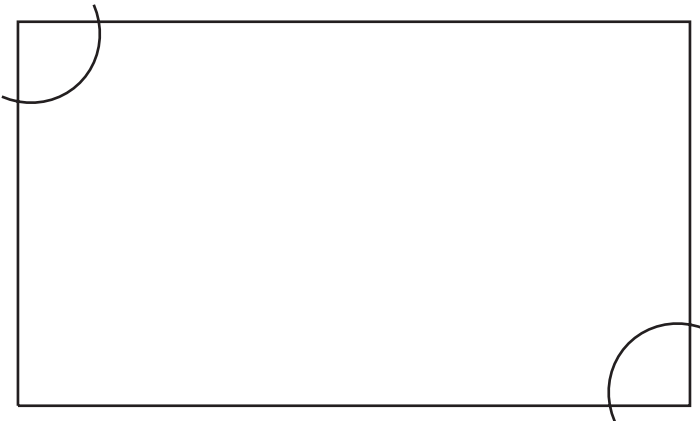
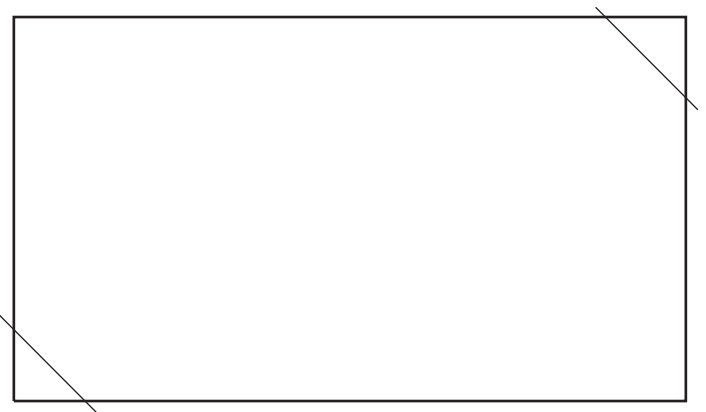
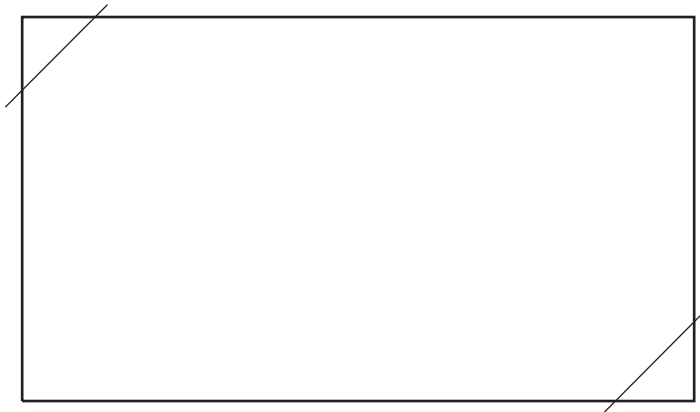
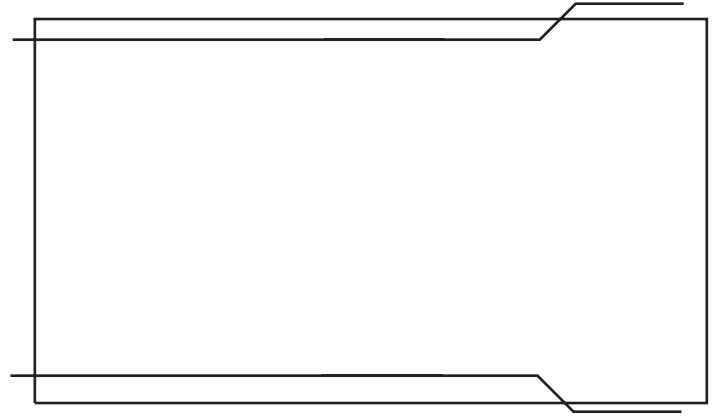
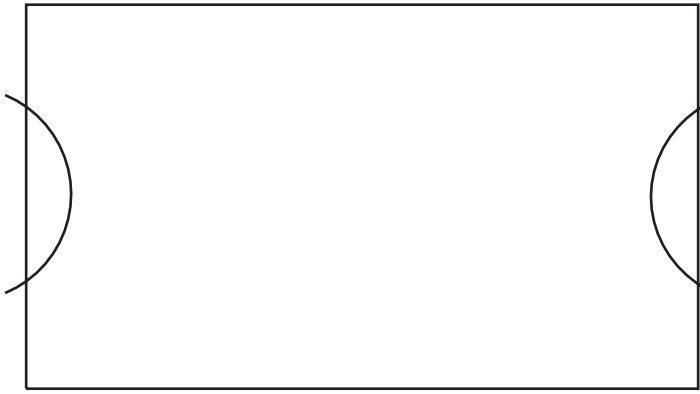

Flagship Press, Incorporated

Die Catalog

Flat Inside View

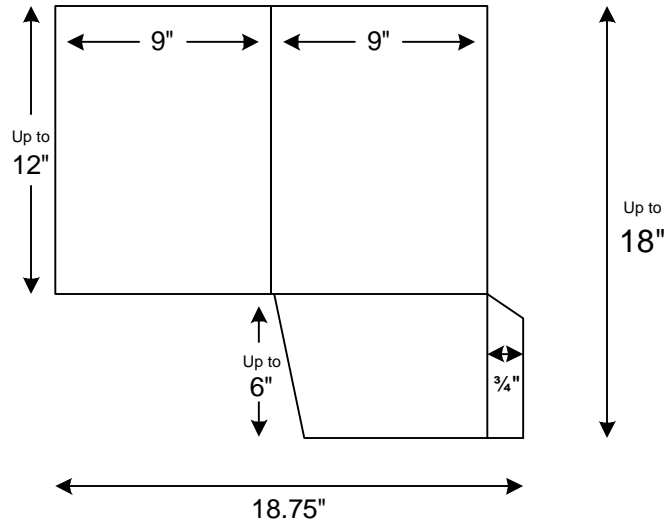

Folded Inside View

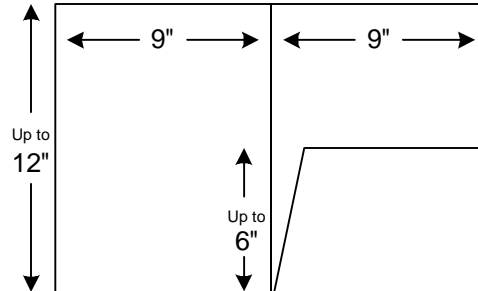

Folded Outside View

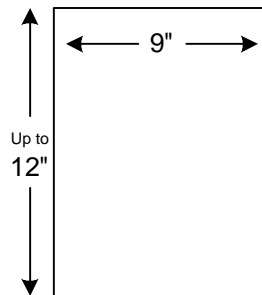

Information

This die makes a 9 x 12 Generic Pocket Folder. This pocket folder has one glued pocket on the back panel. This pocket can be up to 6" tall, and can or not have business card slits centered inside of the pocket. See Business Card Drop-In Selection for style availability.

FP-2001

Flagship Press, Incorporated

Die Catalog

<p style="writing-mode: vertical-rl; transform: rotate(180deg);">Flat Inside View</p>	
<p style="writing-mode: vertical-rl; transform: rotate(180deg);">Folded Inside View</p>	
<p style="writing-mode: vertical-rl; transform: rotate(180deg);">Folded Outside View</p>	
<p style="writing-mode: vertical-rl; transform: rotate(180deg);">Information</p>	<p>This die makes a 8³/₄ x 11¹/₂ Pocket Folder Cover. The back panel is 1/16" shorter to allow for trimming inline on the McCain saddle stitcher. This cover folder also has one glued pocket on the back panel. This pocket can be up to 4" tall, and has business card slits centered inside of the pocket.</p>

Flagship Press, Incorporated Die Catalog

<p>Flat Inside View</p>	
<p>Folded Inside View</p>	
<p>Folded Outside View</p>	
<p>Information</p>	<p>This die makes a 9 x 11½ Expandible Box Pocket Folder. This pocket folder has one glued expandible box pocket on the back panel. This pocket is 4" tall, can expand to 3/16", and has business card slits inside. The center of the folder has a 3/16" spine also</p>

FP-2003

Flagship Press, Incorporated

Die Catalog

<p>Flat Inside View</p>	
<p>Folded Inside View</p>	
<p>Folded Outside View</p>	
<p>Information</p>	<p>This die makes an 8³/₄ x 11¹/₄ Rounded Pocket Folder. This pocket folder has one glued pocket on the back panel. This pocket is 6" tall with a radius edge. The pocket also has radius business card slits centered inside of the pocket.</p>

FP-2004

Flagship Press, Incorporated Die Catalog

Flat Inside View

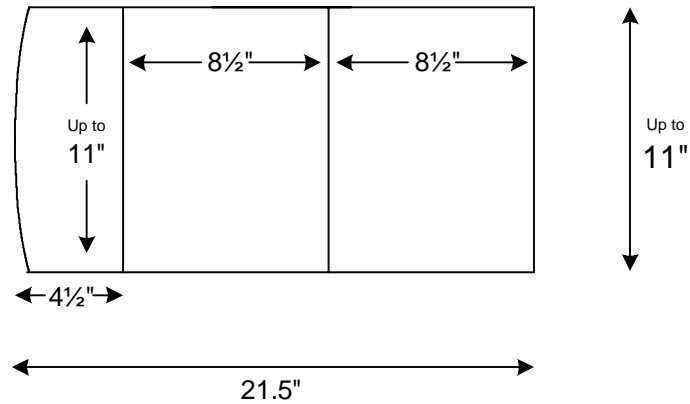

Folded Inside View

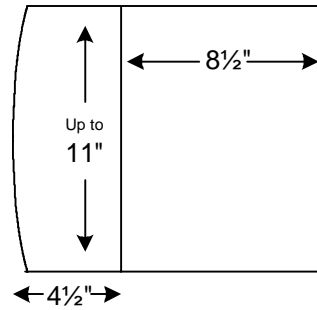

Folded Outside View

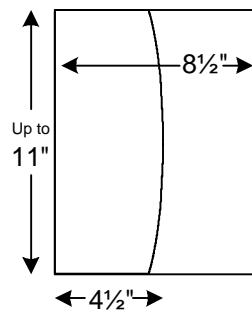

Information

This die makes an 8½ x 11 3 Panel Folder. This folder has one panel that has a radius edge and is shorter than the other two.

FP-2005

Flagship Press, Incorporated

Die Catalog

<p style="writing-mode: vertical-rl; transform: rotate(180deg);">Flat Inside View</p>	
<p style="writing-mode: vertical-rl; transform: rotate(180deg);">Folded Inside View</p>	
<p style="writing-mode: vertical-rl; transform: rotate(180deg);">Folded Outside View</p>	
<p style="writing-mode: vertical-rl; transform: rotate(180deg);">Information</p>	<p>This die makes a 9 x 11³/₄ Pocket Folder. The front panel is 9 x 11³/₄ and the back panel is 9³/₄ x 11³/₄. This pocket folder has one glued pocket on the back panel. This pocket is 4¹/₂" tall with a radius edge, and can or not have business card slits centered inside of the pocket. See Business Card Drop-In Selection for style availability.</p>

FP-2006

Flagship Press, Incorporated Die Catalog

Flat Inside View

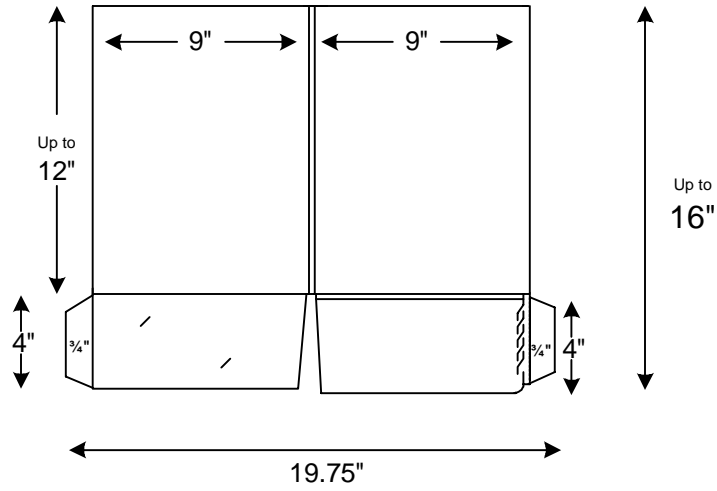

Folded Inside View

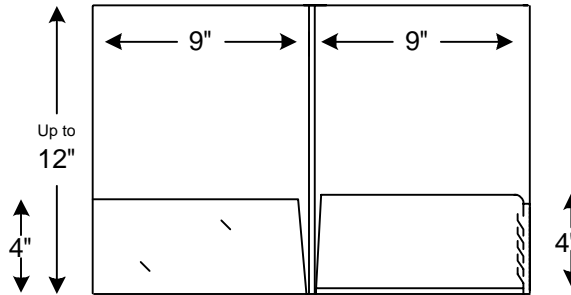

Folded Outside View

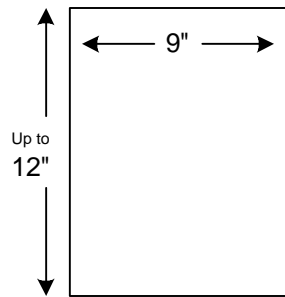

Information

This die makes a 9 x 12 Pocket Folder. This pocket folder has one flat 4" glued pocket on the front panel. It also has an expandible 4" pocket on the back panel.

FP-2007

Flagship Press, Incorporated Die Catalog

<p>Flat Inside View</p>	
<p>Folded Inside View</p>	
<p>Folded Outside View</p>	
<p>Information</p>	<p>This die makes a 8.9375 x 12" Three Panel Pocket Folder. This pocket folder has one glued 4" pocket on the inside right hand side. It also has one unglued 4" pocket in the center panel. It final folds to 8.9375x12.</p>

FP-2008

Flagship Press, Incorporated

Die Catalog

<p style="writing-mode: vertical-rl; transform: rotate(180deg);">Flat Inside View</p>	
<p style="writing-mode: vertical-rl; transform: rotate(180deg);">Folded Inside View</p>	
<p style="writing-mode: vertical-rl; transform: rotate(180deg);">Folded Outside View</p>	
<p style="writing-mode: vertical-rl; transform: rotate(180deg);">Information</p>	<p>This die makes a 7½ x 12¼ Funky Pocket Folder. This pocket folder has one glued pocket on the back panel. This pocket is 6-3/16" tall with a Radius Edge.</p>

FP-2009

Flagship Press, Incorporated

Die Catalog

Flat Inside View

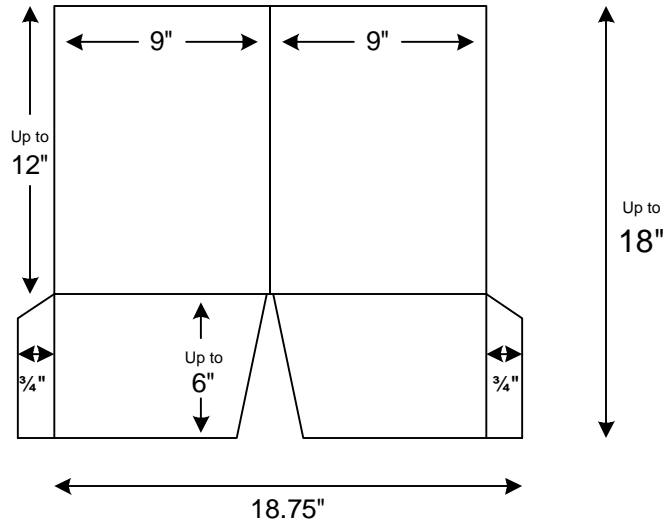

Folded Inside View

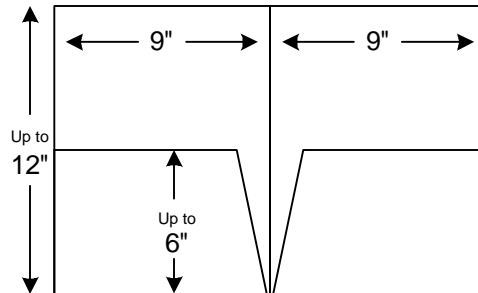

Folded Outside View

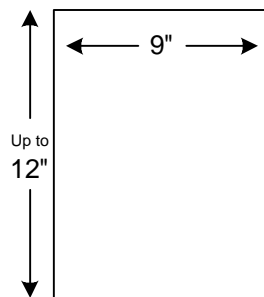

Information

This die makes a 9 x 12 Generic Pocket Folder. This pocket folder has two glued pockets. These pockets can be up to 6" tall, and can or not have business card slits centered inside of the pocket. See Business Card Drop-In Selection for style availability.

FP-2010

Flagship Press, Incorporated

Die Catalog

Flat Inside View

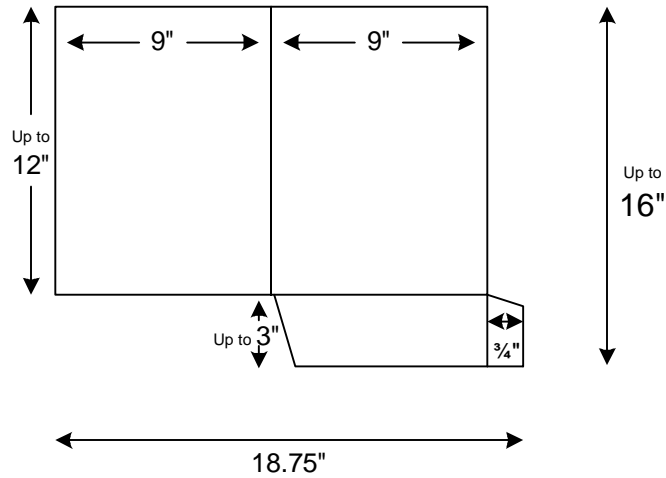

Folded Inside View

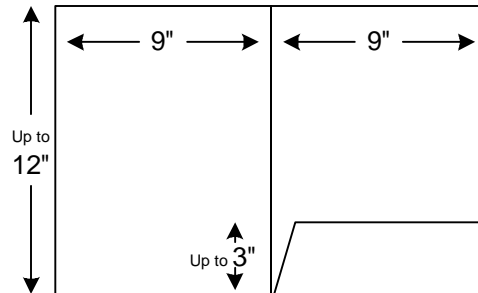

Folded Outside View

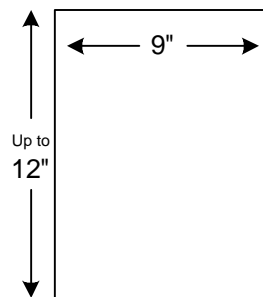

Information

This die makes a 9 x 12 Generic Pocket Folder. This pocket folder has one glued pocket on the back panel. It has a deep "V" center relief. This pocket can be up to 3" tall.

FP-2011

Flagship Press, Incorporated

Die Catalog

Flat Inside View

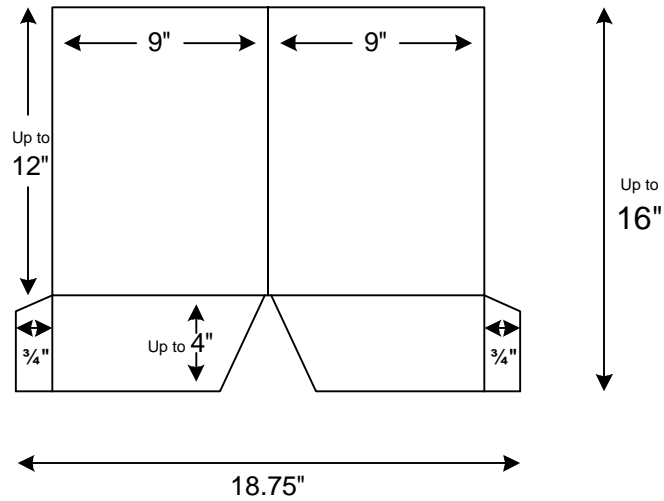

Folded Inside View

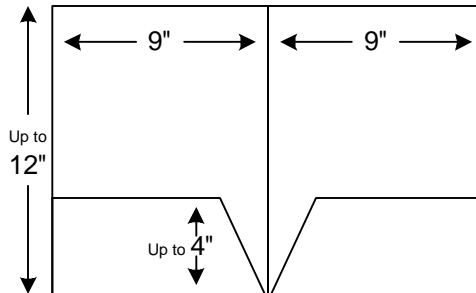

Folded Outside View

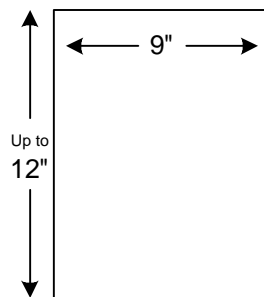

Information

This die makes a 9 x 12 Generic Pocket Folder. This pocket folder has two glued pockets. These pockets can be up to 4" tall. The pockets have a deep relief in the center of the folder.

Flagship Press, Incorporated Die Catalog

Flat Inside View

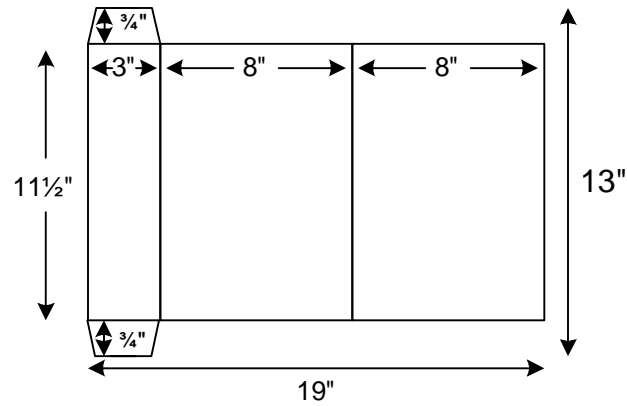

Folded Inside View

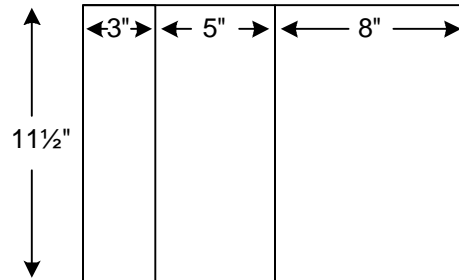

Folded Outside View

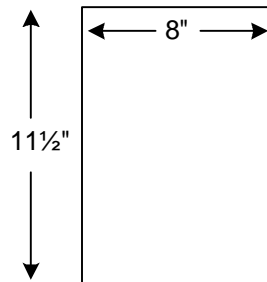

Information

This die makes a 8 x 11 1/2 Generic Vertical Pocket Folder. This pocket folder has one double glued 3" pocket on the front panel. This pocket can be up to 3" wide.

FP-2013

Flagship Press, Incorporated Die Catalog

<p>Flat Inside View</p>	
<p>Folded Inside View</p>	
<p>Folded Outside View</p>	
<p>Information</p>	<p>This die makes a 8-¹⁵/₁₆ X 12 Pocket Folder. This folder has two glued 4" pockets, which has business card slits centered inside of the pocket. This folder also has a 3/16" box styled spine in the center of the two main panels.</p>

Flagship Press, Incorporated

Die Catalog

<p>Flat Inside View</p>	
<p>Folded Inside View</p>	
<p>Folded Outside View</p>	
<p>Information</p>	<p>This die makes a 9 x 12 Generic Pocket Folder. This pocket folder has two glued pockets with radius corners. These pockets are 4" tall. Each pocket can or not have business card slits centered inside of the pocket. See Business Card Drop-In Selection for style availability.</p>

Flagship Press, Incorporated

Die Catalog

Flat Inside View

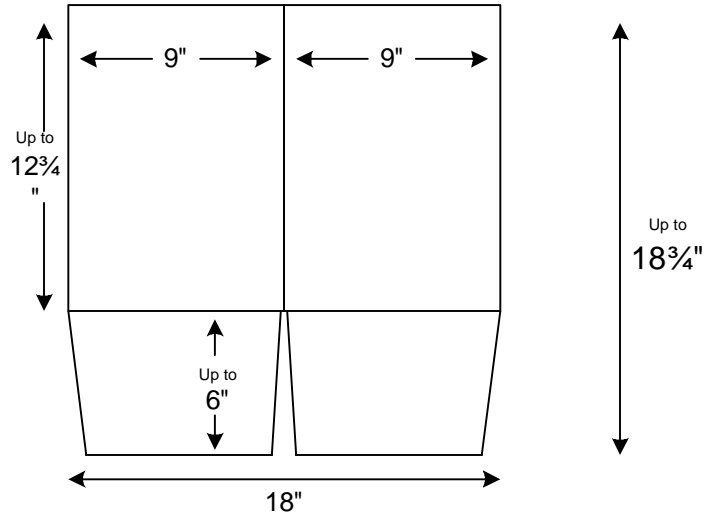

Folded Inside View

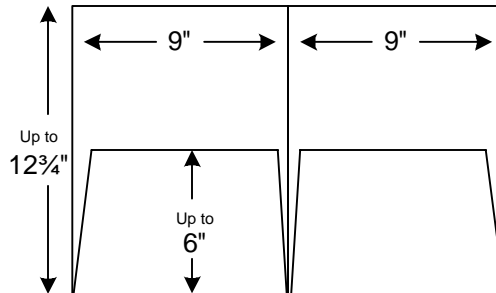

Folded Outside View

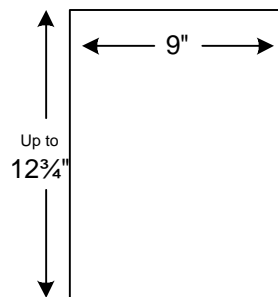

Information

This die makes a 9 x 12 3/4" Generic Pocket Folder. This pocket folder has two unglued pockets. These pockets can be up to 6" tall, and can or not have business card slits centered inside of the pocket. See Business Card Drop-In Selection for style availability.

FP-2016

Flagship Press, Incorporated Die Catalog

<p>Flat Inside View</p>	
<p>Folded Inside View</p>	
<p>Folded Outside View</p>	
<p>Information</p>	<p>This die makes a 9½ x 12¾ Generic Pocket Folder. This pocket folder has two glued pockets. These pockets are up to 6" tall. Each pocket can or not have business card slits centered inside of the pocket. See Business Card Drop-In Selection for style availability.</p>

Flagship Press, Incorporated

Die Catalog

<p>Flat Inside View</p>	
<p>Folded Inside View</p>	
<p>Folded Outside View</p>	
<p>Information</p>	<p>This die makes a 9.1875 x 12.25 Generic Pocket Folder. This pocket folder has two glued pockets with square corners. These pockets are up to 4" tall. Each pocket can or not have business card slits centered inside of the pocket. See Business Card Drop-In Selection for style availability.</p>

Flagship Press, Incorporated

Die Catalog

<p style="writing-mode: vertical-rl; transform: rotate(180deg);">Flat Inside View</p>	
<p style="writing-mode: vertical-rl; transform: rotate(180deg);">Folded Inside View</p>	
<p style="writing-mode: vertical-rl; transform: rotate(180deg);">Folded Outside View</p>	
<p style="writing-mode: vertical-rl; transform: rotate(180deg);">Information</p>	<p>This die makes a 3 Panel 9 x 12 Generic Pocket Folder. This pocket folder has one glued pocket in the center panel. This pocket can be up to 5" tall. It also can have or not have business card slits centered inside of the pocket. See Business Card Drop-In Selection for style availability.</p>

Flagship Press, Incorporated Die Catalog

Flat Inside View

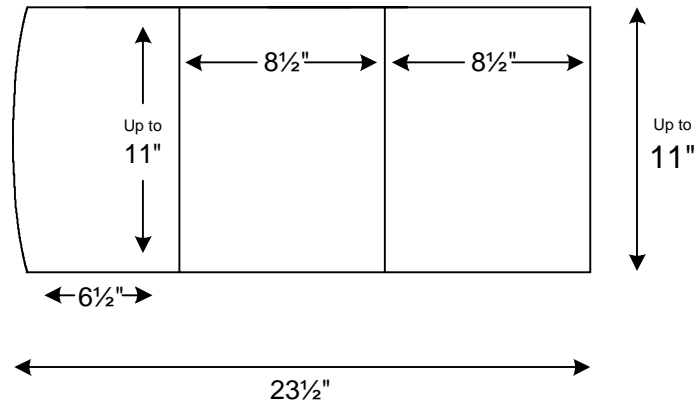

Folded Inside View

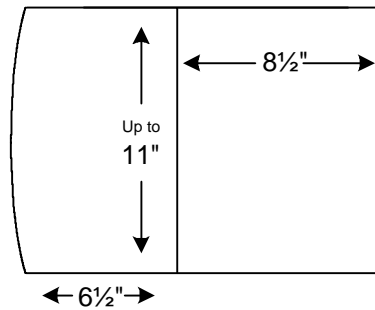

Folded Outside View

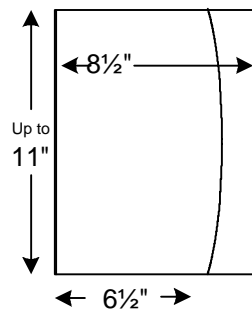

Information

This die makes an 8 1/2 x 11 3 Panel Folder. This folder has one panel that has a radius edge and is shorter than the other two.

FP-2020

Flagship Press, Incorporated Die Catalog

Flat Inside View

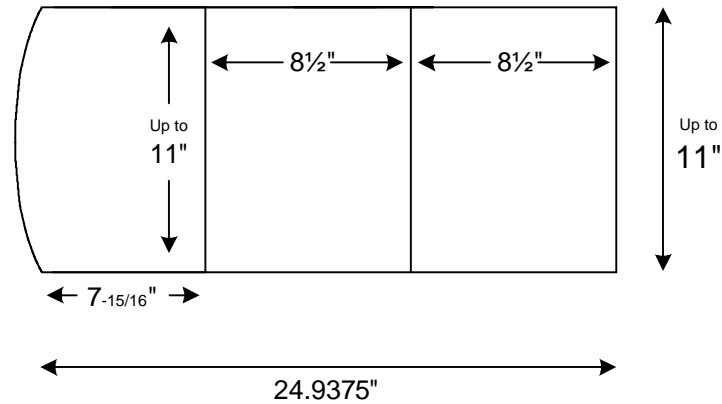

Folded Inside View

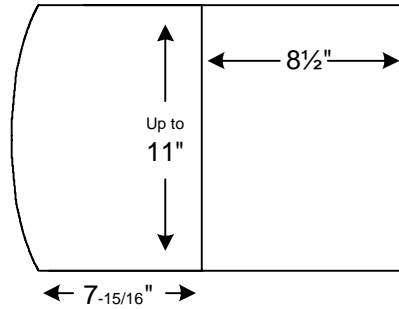

Folded Outside View

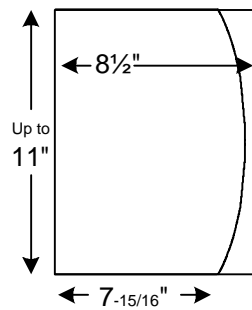

Information

This die makes an $8\frac{1}{2} \times 11$ 3 Panel Folder. This folder has one panel that has a radius edge and is shorter than the other two.

FP-2021

Flagship Press, Incorporated

Die Catalog

<p style="writing-mode: vertical-rl; transform: rotate(180deg);">Flat Inside View</p>	
<p style="writing-mode: vertical-rl; transform: rotate(180deg);">Folded Inside View</p>	
<p style="writing-mode: vertical-rl; transform: rotate(180deg);">Folded Outside View</p>	
<p style="writing-mode: vertical-rl; transform: rotate(180deg);">Information</p>	<p>This die makes a 9 x 12 Sail Pocket Folder with a Funky knotch in the front panel (this knotch can be remove if requested). This pocket folder has one glued 12 Sail Pocket on the back panel.</p>

Flagship Press, Incorporated

Die Catalog

<p style="writing-mode: vertical-rl; transform: rotate(180deg);">Flat Inside View</p>	
<p style="writing-mode: vertical-rl; transform: rotate(180deg);">Folded Inside View</p>	
<p style="writing-mode: vertical-rl; transform: rotate(180deg);">Folded Outside View</p>	
<p style="writing-mode: vertical-rl; transform: rotate(180deg);">Information</p>	<p>This die makes a 3 Panel 8³/₄ x 12 Generic Pocket Folder. This pocket folder has one glued pocket on the last panel. This pocket can be up to 3¹/₂" tall. It also can have or not have business card slits centered inside of the pocket. See Business Card Drop-In Selection for style availability.</p>

Flagship Press, Incorporated

Die Catalog

<p>Flat Inside View</p>	
<p>Folded Inside View</p>	
<p>Folded Outside View</p>	
<p>Information</p>	<p>This die makes a 7 x 10 Pocket Folder. This pocket folder has one glued pocket on the back panel. This pocket is up to 5 1/2" tall. The pocket also has generic business card slits.</p>

Flagship Press, Incorporated Die Catalog

<p style="writing-mode: vertical-rl; transform: rotate(180deg);">Flat Inside View</p>	
<p style="writing-mode: vertical-rl; transform: rotate(180deg);">Folded Inside View</p>	
<p style="writing-mode: vertical-rl; transform: rotate(180deg);">Folded Outside View</p>	
<p style="writing-mode: vertical-rl; transform: rotate(180deg);">Information</p>	<p>This die makes a 9 x 12 Sail Pocket Folder. This pocket folder has one glued 11½" Sail Pocket on the back panel. This panel can or not have Standard BusinessCard Slits.</p>

FP-2025

Flagship Press, Incorporated Die Catalog

<p style="writing-mode: vertical-rl; transform: rotate(180deg);">Flat Inside View</p>	
<p style="writing-mode: vertical-rl; transform: rotate(180deg);">Folded Inside View</p>	
<p style="writing-mode: vertical-rl; transform: rotate(180deg);">Folded Outside View</p>	
<p style="writing-mode: vertical-rl; transform: rotate(180deg);">Information</p>	<p>This die makes a 9 x 12 Sail Pocket Folder. This pocket folder has one glued 11 1/4" Sail Pocket on the back panel.</p>

FP-2026

Flagship Press, Incorporated

Die Catalog

<p style="writing-mode: vertical-rl; transform: rotate(180deg);">Flat Inside View</p>	
<p style="writing-mode: vertical-rl; transform: rotate(180deg);">Folded Inside View</p>	
<p style="writing-mode: vertical-rl; transform: rotate(180deg);">Folded Outside View</p>	
<p style="writing-mode: vertical-rl; transform: rotate(180deg);">Information</p>	<p>This die makes a 9 x 12 Generic Pocket Folder. This pocket folder has one glued pocket on the back panel. This pocket is 5" tall, and can or not have business card slits centered inside of the pocket. See Business Card Drop-In Selection for style availability.</p>

Flagship Press, Incorporated

Die Catalog

<p>Flat Inside View</p>	<p>Up to 11½"</p> <p>8 7/16"</p> <p>Up to 15"</p> <p>Up to 3½"</p> <p>3/4"</p> <p>18.75"</p>
<p>Folded Inside View</p>	<p>Up to 11½"</p> <p>8 7/16"</p> <p>Up to 3½"</p>
<p>Folded Outside View</p>	<p>Up to 11½"</p> <p>8 7/16"</p>
<p>Information</p>	<p>This die makes a 8-7/16 X 11½ Generic Pocket Folder. This pocket folder has one glued pocket on the back panel. This pocket can be up to 3½" tall, and can or not have business card slits centered inside of the pocket. See Business Card Drop-In Selection for style availability.</p>

FP-2028

Flagship Press, Incorporated

Die Catalog

<p style="writing-mode: vertical-rl; transform: rotate(180deg);">Flat Inside View</p>	
<p style="writing-mode: vertical-rl; transform: rotate(180deg);">Folded Inside View</p>	
<p style="writing-mode: vertical-rl; transform: rotate(180deg);">Folded Outside View</p>	
<p style="writing-mode: vertical-rl; transform: rotate(180deg);">Information</p>	<p>This die makes a 9 x 12 Generic Pocket Folder. This pocket folder has one glued pocket on the back panel. This pocket is 5" tall, sloping down to 3". This pocket can or not have standard business card slits off-centered inside of the pocket.</p>

Flagship Press, Incorporated

Die Catalog

Flat Inside View

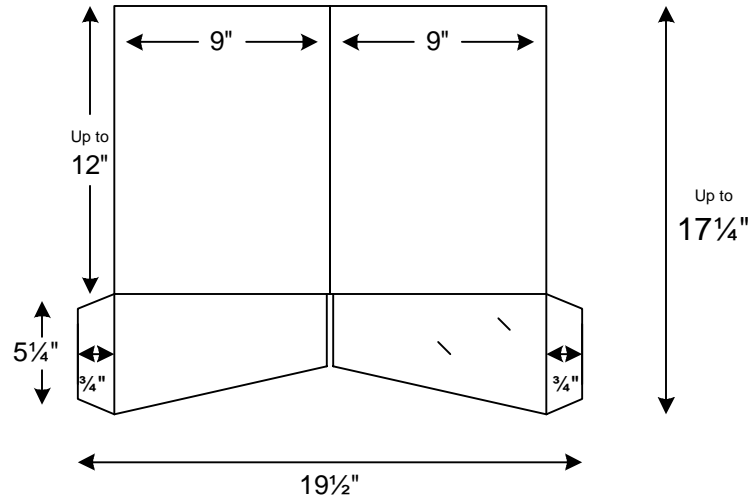

Folded Inside View

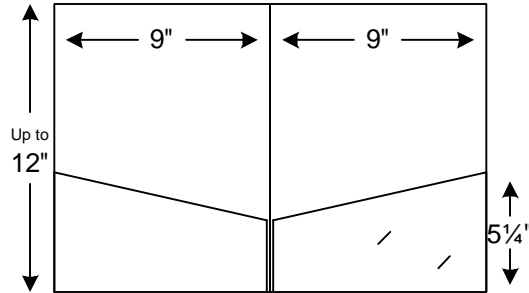

Folded Outside View

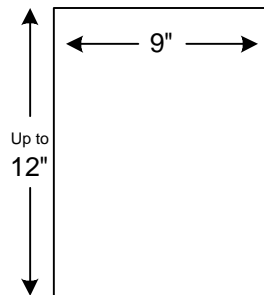

Information

This die makes a 9 x 12 Generic Pocket Folder. This pocket folder has two glued pockets. These pockets are 5 1/4" tall, sloping down to 3". This pocket can or not have standard business card slits off-centered inside of the pocket. See Business Card Drop-In Selection for style availability.

FP-2030

Flagship Press, Incorporated

Die Catalog

Flat Inside View

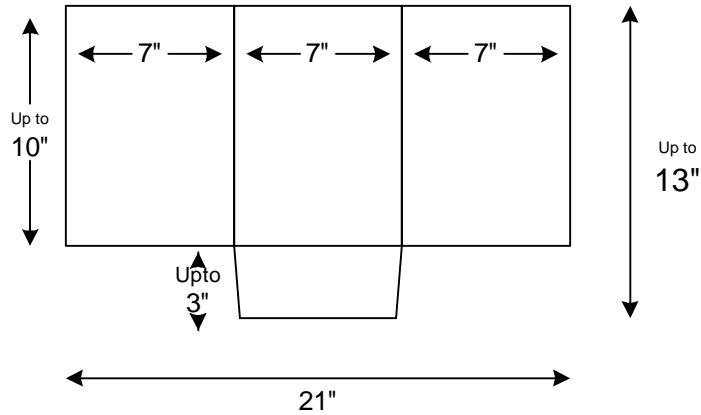

Folded Inside View

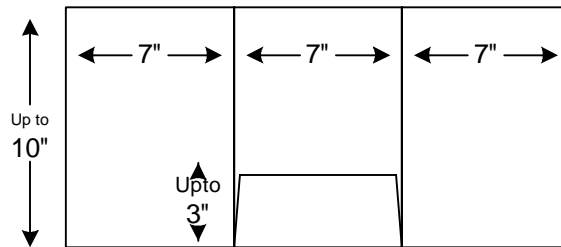

Folded Outside View

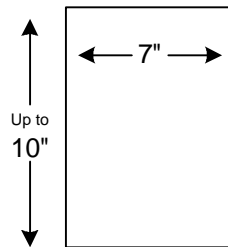

Information

This die makes a 7 x 10 Generic 3 Panel Pocket Folder. This pocket folder has one unglued pocket. This pocket is 3" tall. This pocket can or not have standard business card slits centered inside of the pocket. See Business Card Drop-In Selection for style availability.

FP-2031

Flagship Press, Incorporated

Die Catalog

Flat Inside View

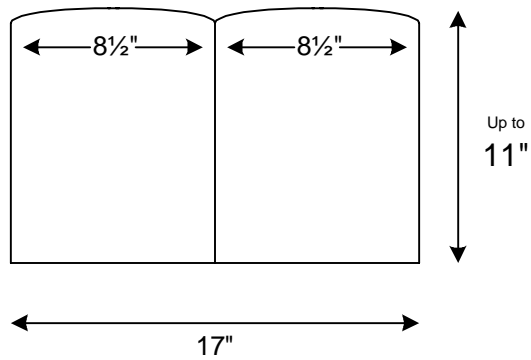

Folded Inside View

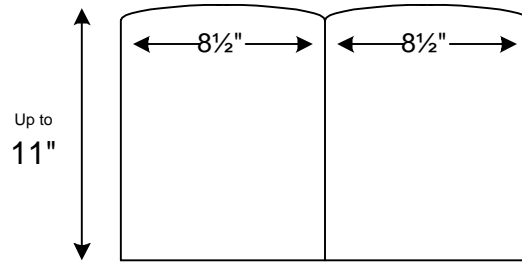

Folded Outside View

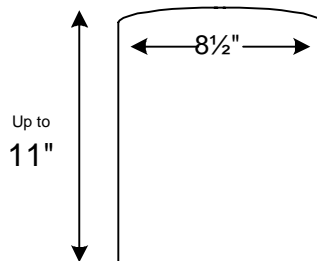

Information

This die makes a $8\frac{1}{2}$ x 11 Generic 2 Panel Brochure. This brochure has a radius / beveled top edge.

FP-2032

Flagship Press, Incorporated

Die Catalog

Flat Inside View

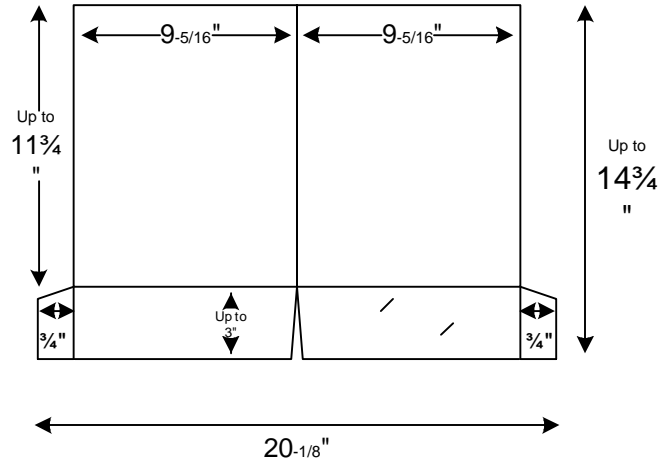

Folded Inside View

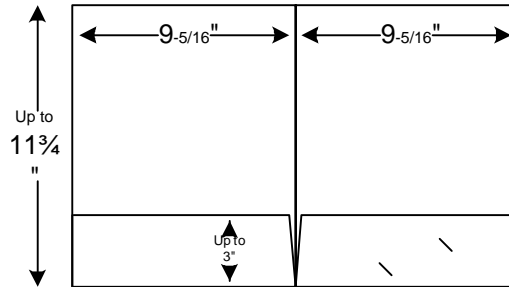

Folded Outside View

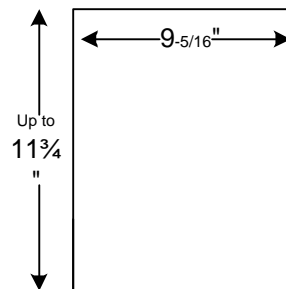

Information

This die makes a 9-5/16 X 11-3/4 Generic Pocket Folder. This pocket folder has two glued pockets. These pockets can be up to 3" tall, and can or not have business card slits centered inside of the pocket. See Business Card Drop-In Selection for style availability.

FP-2033

Flagship Press, Incorporated

Die Catalog

<p style="writing-mode: vertical-rl; transform: rotate(180deg);">Flat Inside View</p>	
<p style="writing-mode: vertical-rl; transform: rotate(180deg);">Folded Inside View</p>	
<p style="writing-mode: vertical-rl; transform: rotate(180deg);">Folded Outside View</p>	
<p style="writing-mode: vertical-rl; transform: rotate(180deg);">Information</p>	<p>This die makes a 8½ x 11½ Pocket Folder Cover. This cover folder has one glued pocket on the back panel. This pocket can be up to 3½" tall, and can or not have business card slits centered inside of the pocket. See Business Card Drop-In Selection for style availability.</p>

FP-2034

Flagship Press, Incorporated

Die Catalog

<p style="writing-mode: vertical-rl; transform: rotate(180deg);">Flat Inside View</p>	
<p style="writing-mode: vertical-rl; transform: rotate(180deg);">Folded Inside View</p>	
<p style="writing-mode: vertical-rl; transform: rotate(180deg);">Folded Outside View</p>	
<p style="writing-mode: vertical-rl; transform: rotate(180deg);">Information</p>	<p>This die makes a 3 Panel 9 x 12 Generic Pocket Folder. This pocket folder has one double glued pocket in the center panel. This pocket can be up to 6" tall. It also has business card slits inside of the pocket.</p>

FP-2035

Flagship Press, Incorporated

Die Catalog

<p style="writing-mode: vertical-rl; transform: rotate(180deg);">Flat Inside View</p>	
<p style="writing-mode: vertical-rl; transform: rotate(180deg);">Folded Inside View</p>	
<p style="writing-mode: vertical-rl; transform: rotate(180deg);">Folded Outside View</p>	
<p style="writing-mode: vertical-rl; transform: rotate(180deg);">Information</p>	<p>This die makes a 9 x 12 Pocket Folder. This pocket folder has one glued pocket on the back panel. This pocket is 4" tall with a radius edge, and has business card slits off-centered inside of the pocket.</p>

FP-2036

Flagship Press, Incorporated

Die Catalog

Flat Inside View

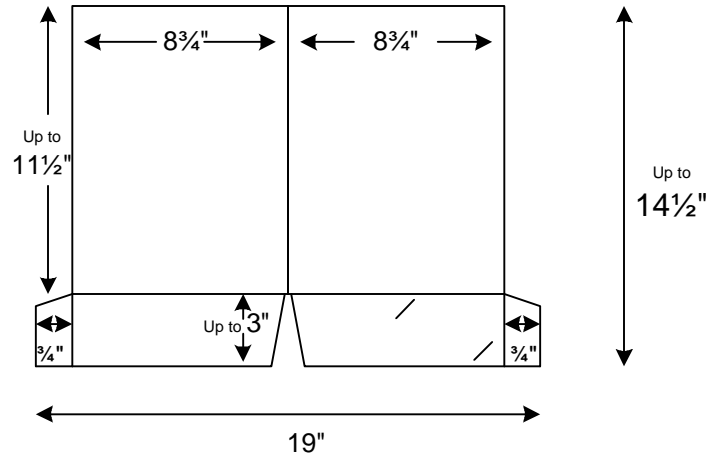

Folded Inside View

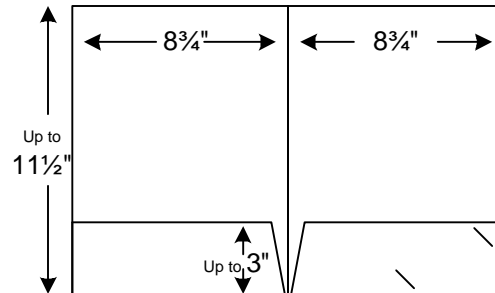

Folded Outside View

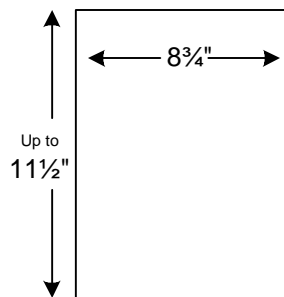

Information

This die makes a 8¾ x 11½ Pocket Folder. This folder has two glued 3" pockets. The pocket on the back panel has business card slits

FP-2037

Flagship Press, Incorporated

Die Catalog

<p>Flat Inside View</p>	<p>Up to 11 1/2"</p> <p>8 3/4"</p> <p>8 3/4"</p> <p>Up to 16 1/2"</p> <p>Up to 5"</p> <p>3/4"</p> <p>19"</p>
<p>Folded Inside View</p>	<p>Up to 11 1/2"</p> <p>8 3/4"</p> <p>8 3/4"</p> <p>Up to 5"</p>
<p>Folded Outside View</p>	<p>Up to 11 1/2"</p> <p>8 3/4"</p>
<p>Information</p>	<p>This die makes a 8 3/4 x 11 1/2 Pocket Folder. This folder has one glued up to 5" pockets. This pocket can or not have business card slits. See Business Card Drop-In Selection for style availability.</p>

FP-2038

Flagship Press, Incorporated

Die Catalog

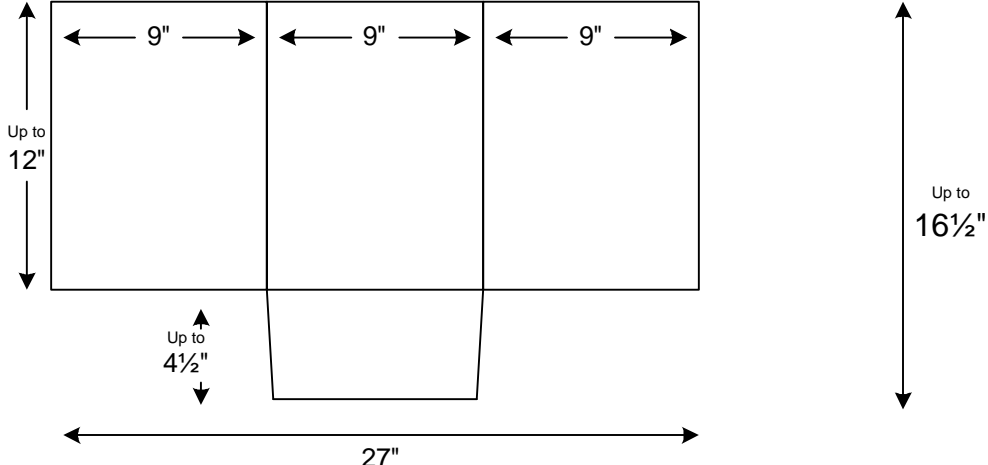
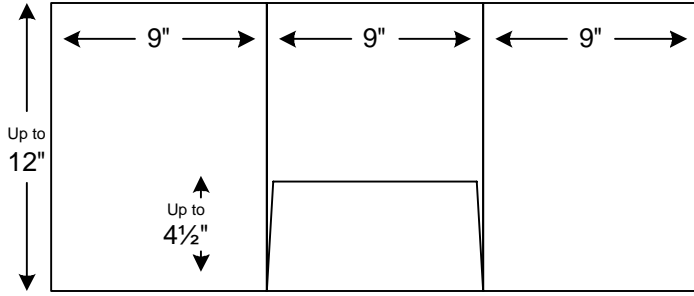
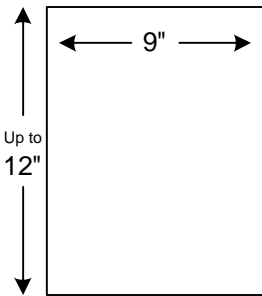
<p style="writing-mode: vertical-rl; transform: rotate(180deg);">Flat Inside View</p>	
<p style="writing-mode: vertical-rl; transform: rotate(180deg);">Folded Inside View</p>	
<p style="writing-mode: vertical-rl; transform: rotate(180deg);">Folded Outside View</p>	
<p style="writing-mode: vertical-rl; transform: rotate(180deg);">Information</p>	<p>This die makes a 3 Panel 9 x 12 Generic Pocket Folder. This pocket folder has one unglued pocket in the center panel. This pocket can be up to 4½" tall. It also can have or not have business card slits centered inside of the pocket. See Business Card Drop-In Selection for style availability.</p>

FP-2039

Flagship Press, Incorporated

Die Catalog

<p>Flat Inside View</p>	
<p>Folded Inside View</p>	
<p>Folded Outside View</p>	
<p>Information</p>	<p>This die makes a 9 x 12 Pocket Folder. This pocket folder has one glued pocket on the back panel. This pocket IS 4" tall, and it has 2 sets of business card slits inside of the pocket.</p>

FP-2040

Flagship Press, Incorporated

Die Catalog

<p style="writing-mode: vertical-rl; transform: rotate(180deg);">Flat Inside View</p>	
<p style="writing-mode: vertical-rl; transform: rotate(180deg);">Folded Inside View</p>	
<p style="writing-mode: vertical-rl; transform: rotate(180deg);">Folded Outside View</p>	
<p style="writing-mode: vertical-rl; transform: rotate(180deg);">Information</p>	<p>This die makes a 3 Panel 8³/₄ x 11¹/₄ Pocket Folder. This pocket folder has one unglued pocket on the center panel. This pocket can be up to 3¹/₂" tall. It also has business card slits inside of the pocket.</p>

FP-2041

Flagship Press, Incorporated

Die Catalog

<p>Flat Inside View</p>	<p>Up to 11"</p> <p>8 1/4"</p> <p>8 1/4"</p> <p>Up to 16"</p> <p>Up to 5"</p> <p>3/4"</p> <p>17 1/4"</p>
<p>Folded Inside View</p>	<p>Up to 11"</p> <p>8 1/4"</p> <p>8 1/4"</p> <p>Up to 5"</p>
<p>Folded Outside View</p>	<p>Up to 11"</p> <p>8 1/4"</p>
<p>Information</p>	<p>This die makes a 8 1/4 x 11 Generic Pocket Folder. This pocket folder has one glued pocket on the back panel. This pocket can be up to 5" tall, and can or not have business card slits centered inside of the pocket. See Business Card Drop-In Selection for style availability.</p>

Flagship Press, Incorporated

Die Catalog

<p>Flat Inside View</p>	
<p>Folded Inside View</p>	
<p>Folded Outside View</p>	
<p>Information</p>	<p>This die makes a 8.5625 x 12 Generic Pocket Folder. This pocket folder has two glued pockets. These pockets can be up to 6" tall, and can or not have business card slits centered inside of the pocket. See Business Card Drop-In Selection for style availability.</p>

FP-2043

Flagship Press, Incorporated

Die Catalog

<p>Flat Inside View</p>	<p>Up to 11"</p> <p>7 1/2"</p> <p>7 1/2"</p> <p>Up to 15"</p> <p>Up to 4"</p> <p>3/4"</p> <p>15 3/4"</p>
<p>Folded Inside View</p>	<p>Up to 11"</p> <p>7 1/2"</p> <p>7 1/2"</p> <p>Up to 4"</p>
<p>Folded Outside View</p>	<p>Up to 11"</p> <p>7 1/2"</p>
<p>Information</p>	<p>This die makes a 7 1/2 x 11 Generic Pocket Folder. This pocket folder has one glued pocket on the back panel. This pocket can be up to 4" tall, and can or not have business card slits centered inside of the pocket. See Business Card Drop-In Selection for style availability.</p>

FP-2044

Flagship Press, Incorporated

Die Catalog

<p style="writing-mode: vertical-rl; transform: rotate(180deg);">Flat Inside View</p>	<p>Up to 12 1/4"</p> <p>9"</p> <p>9"</p> <p>Up to 16 1/4"</p> <p>3/4"</p> <p>Up to 4"</p> <p>Up to 4"</p> <p>3/4"</p> <p>19 3/4"</p>
<p style="writing-mode: vertical-rl; transform: rotate(180deg);">Folded Inside View</p>	<p>Up to 12 1/4"</p> <p>9"</p> <p>9"</p> <p>Up to 4"</p> <p>Up to 4"</p>
<p style="writing-mode: vertical-rl; transform: rotate(180deg);">Folded Outside View</p>	<p>Up to 12"</p> <p>9"</p>
<p style="writing-mode: vertical-rl; transform: rotate(180deg);">Information</p>	<p>This die makes a 9 x 12 Generic Pocket Folder with a 1/4" spine. This pocket folder has two glued pockets with radius corners. These pockets are 4" tall. Each pocket can or not have business card slits centered inside of the pocket. See Business Card Drop-In Selection for style availability.</p>

FP-2045

Flagship Press, Incorporated

Die Catalog

<p>Flat Inside View</p>	<p>Up to 12"</p> <p>8 3/4"</p> <p>8 3/4"</p> <p>Up to 4"</p> <p>3/4"</p> <p>3/4"</p> <p>19"</p> <p>Up to 16"</p>
<p>Folded Inside View</p>	<p>Up to 12"</p> <p>8 3/4"</p> <p>8 3/4"</p> <p>Up to 4"</p>
<p>Folded Outside View</p>	<p>Up to 12"</p> <p>8 3/4"</p>
<p>Information</p>	<p>This die makes a 8 3/4 x 12 Generic Pocket Folder. This pocket folder has two glued pockets on the back panel. These pockets can be up to 4" tall, and can or not have business card slits centered inside of the pocket. See Business Card Drop-In Selection for style availability.</p>

FP-2046

Flagship Press, Incorporated

Die Catalog

<p>Flat Inside View</p>	
<p>Folded Inside View</p>	
<p>Folded Outside View</p>	
<p>Information</p>	<p>This die makes a 8^{5/8} x 11^{1/8} Generic Pocket Folder. This pocket folder has one glued pocket on the back panel. This pocket can be up to 4" tall, and can or not have business card slits centered inside of the pocket. See Business Card Drop-In Selection for style availability.</p>

Flagship Press, Incorporated

Die Catalog

<p style="writing-mode: vertical-rl; transform: rotate(180deg);">Flat Inside View</p>	
<p style="writing-mode: vertical-rl; transform: rotate(180deg);">Folded Inside View</p>	
<p style="writing-mode: vertical-rl; transform: rotate(180deg);">Folded Outside View</p>	
<p style="writing-mode: vertical-rl; transform: rotate(180deg);">Information</p>	<p>This die makes a 3 Panel 9 x 12 Generic Pocket Folder. This pocket folder has one glued pocket in the back panel. This pocket can be up to 6" tall. It also can have or not have business card slits centered inside of the pocket. See Business Card Drop-In Selection for style availability.</p>

FP-2048

Flagship Press, Incorporated

Die Catalog

<p style="writing-mode: vertical-rl; transform: rotate(180deg);">Flat Inside View</p>	
<p style="writing-mode: vertical-rl; transform: rotate(180deg);">Folded Inside View</p>	
<p style="writing-mode: vertical-rl; transform: rotate(180deg);">Folded Outside View</p>	
<p style="writing-mode: vertical-rl; transform: rotate(180deg);">Information</p>	<p>This die makes a 3 Panel 8³/₄ x 12 Generic Pocket Folder. This pocket folder has one glued pocket on the last panel. This pocket can be up to 6" tall. It also can have or not have business card slits centered inside of the pocket. See Business Card Drop-In Selection for style availability.</p>

FP-2049

Flagship Press, Incorporated

Die Catalog

<p style="writing-mode: vertical-rl; transform: rotate(180deg);">Flat Inside View</p>	
<p style="writing-mode: vertical-rl; transform: rotate(180deg);">Folded Inside View</p>	
<p style="writing-mode: vertical-rl; transform: rotate(180deg);">Folded Outside View</p>	
<p style="writing-mode: vertical-rl; transform: rotate(180deg);">Information</p>	<p>This die makes a 10-7/8 x 12 Generic Pocket Folder. This pocket folder has two glued pockets. These pockets can be up to 5" tall, and can or not have business card slits centered inside of the pocket. See Business Card Drop-In Selection for style availability.</p>

FP-2050

Flagship Press, Incorporated

Die Catalog

<p>Flat Inside View</p>	
<p>Folded Inside View</p>	
<p>Folded Outside View</p>	
<p>Information</p>	<p>This die makes a 8½ x 11" Generic Pocket Folder. This pocket folder has one glued pocket on the back panel. This pocket can be up to 6" tall, and can or not have business card slits centered inside of the pocket. See Business Card Drop-In Selection for style availability.</p>

FP-2051

Flagship Press, Incorporated

Die Catalog

Flat Inside View

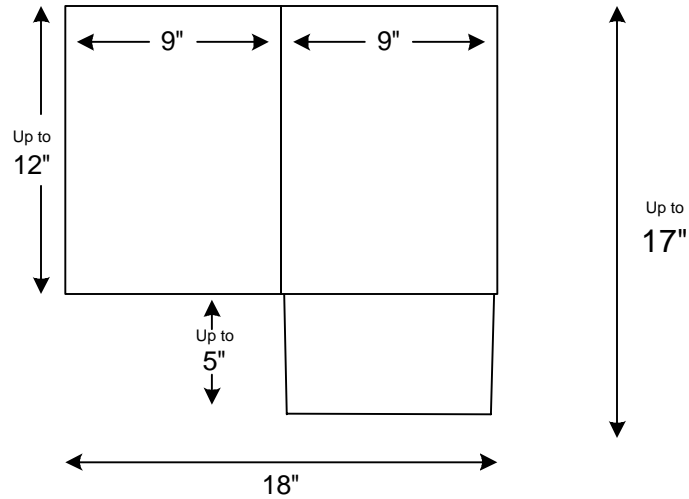

Folded Inside View

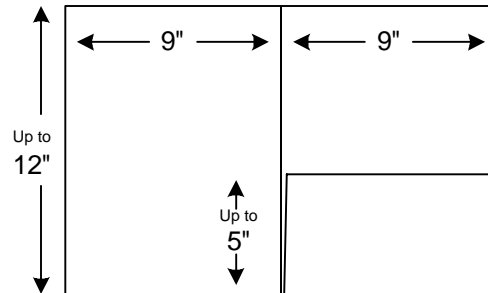

Folded Outside View

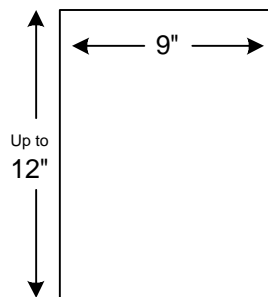

Information

This die makes a 9 x 12" Generic Pocket Folder. This pocket folder has one unglued pocket. These pockets can be up to 5" tall, and can or not have business card slits centered inside of the pocket. See Business Card Drop-In Selection for style availability.

FP-2052

Flagship Press, Incorporated

Die Catalog

<p style="writing-mode: vertical-rl; transform: rotate(180deg);">Flat Inside View</p>	
<p style="writing-mode: vertical-rl; transform: rotate(180deg);">Folded Inside View</p>	
<p style="writing-mode: vertical-rl; transform: rotate(180deg);">Folded Outside View</p>	
<p style="writing-mode: vertical-rl; transform: rotate(180deg);">Information</p>	<p>This die makes a 9-1/8 x 12^{3/4} Generic Pocket Folder. This pocket folder has two glued pockets. These pockets can be up to 6" tall, and can or not have business card slits centered inside of the pocket. See Business Card Drop-In Selection for style availability.</p>

FP-2053

Flagship Press, Incorporated

Die Catalog

<p>Flat Inside View</p>	
<p>Folded Inside View</p>	
<p>Folded Outside View</p>	
<p>Information</p>	<p>This die makes a 9 x 12 Generic Pocket Folder. This pocket folder has one glued square pocket on the front panel. This pocket can be up to 6" tall, and can or not have business card slits centered inside of the pocket. See Business Card Drop-In Selection for style availability.</p>

FP-2054